









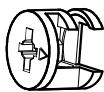
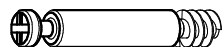

| | | | | |
|---|--|---|--|---|
|  Ø6,3x50 mm A1 x 30 |  Ø12 mm A2 x 30 |  4 mm A3 x 1 |  Ø15x12 mm B1 x 10 |  Ø5x44 mm B2 x 10 |
|  Ø20 mm B3 x 10 |  Ø12x3 mm C x 6 |  Ø4x16 mm D1 x 42 |  Ø4x20 mm D2 x 22 |  Ø1,6x25 mm F x 143 |
|  Ø8x36 mm G x 30 |  I x 3 |  K x 3 |  N x 2 |  256 mm O1 x 2 |
|  437 mm O2 x 2 | | | | |
| | | | | |

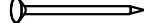
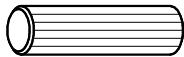
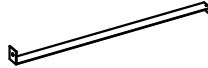
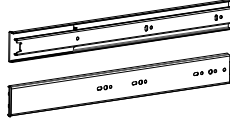
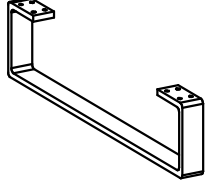
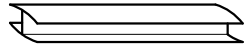
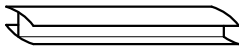
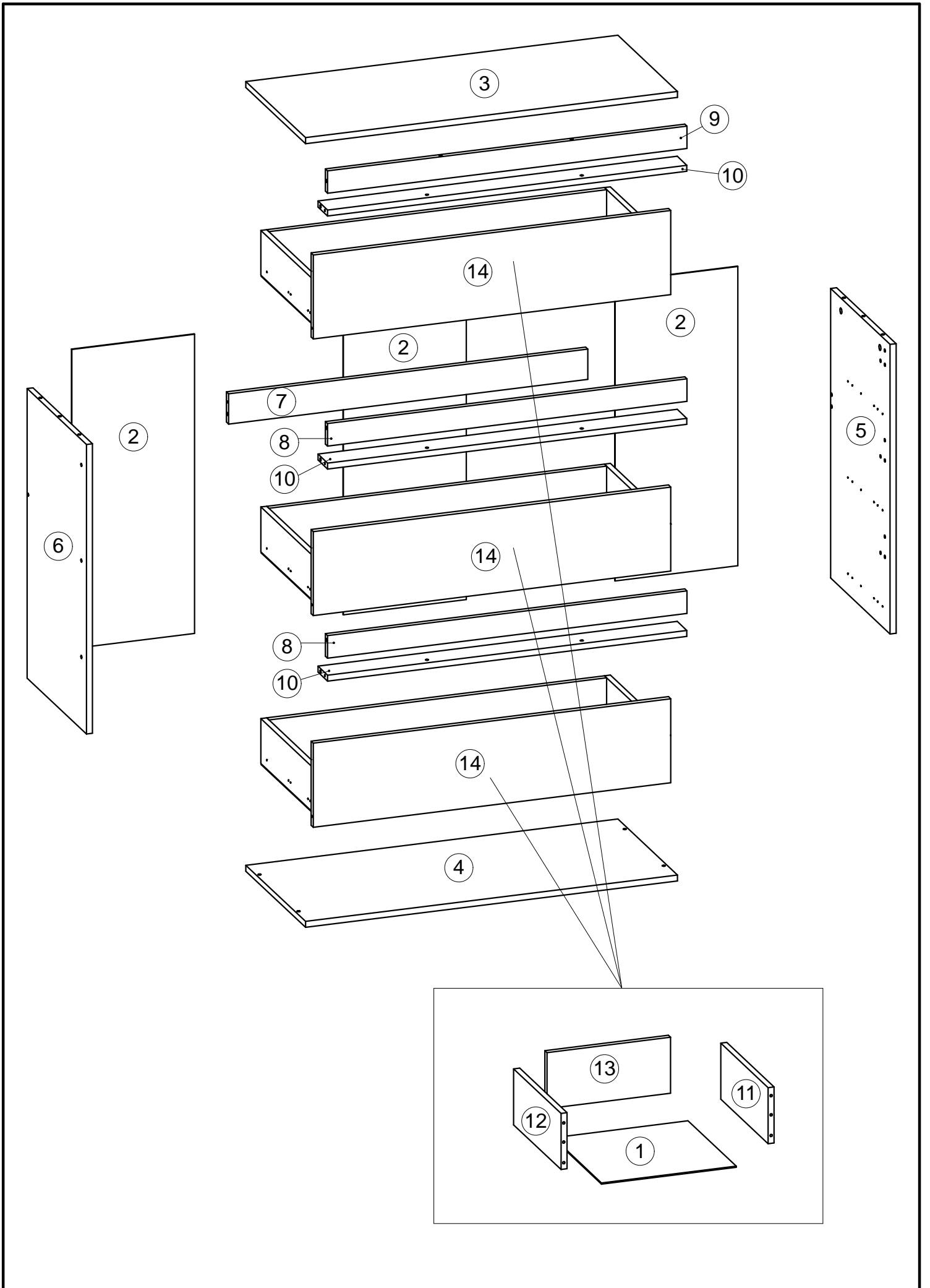

Box 1/2

938x406x3 mm

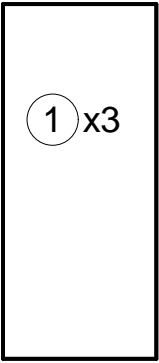

804x330x3 mm

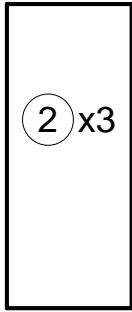

999x440x16 mm

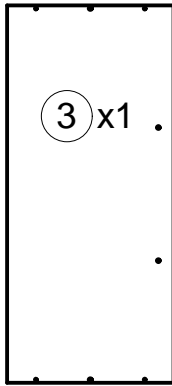

999x440x16 mm

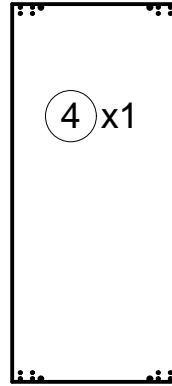

960x225x16 mm

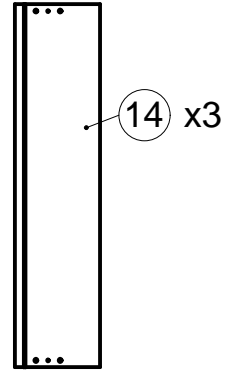

400x120x16 mm

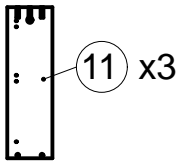

400x120x16 mm

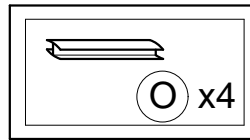
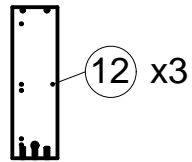

Fittings & Tools

Box 2/2

778x439x16 mm

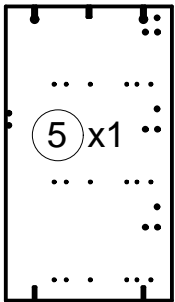

778x439x16 mm

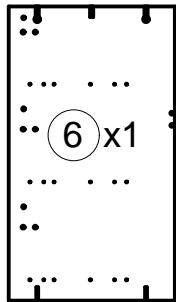

966x80x16 mm

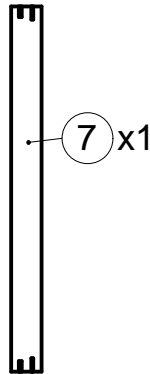

966x60x16 mm

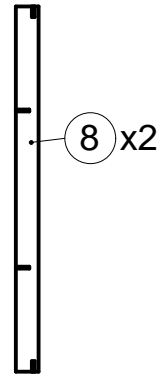

966x60x16 mm

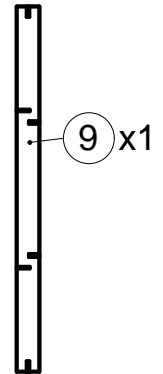

966x70x16 mm

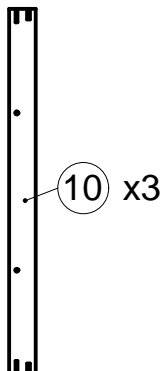

908x120x16 mm

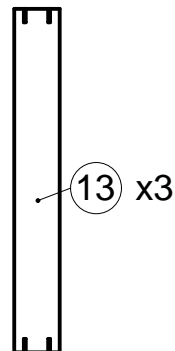

1

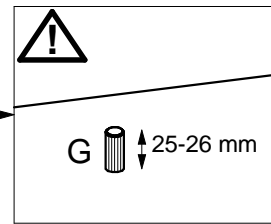
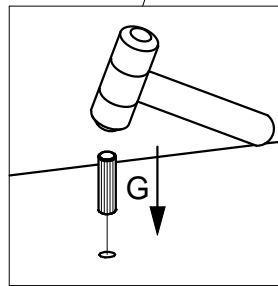
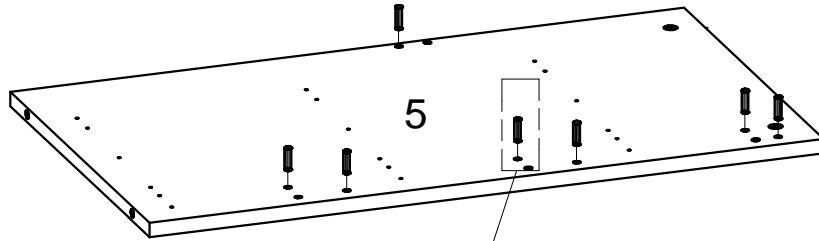
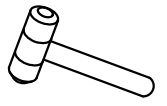
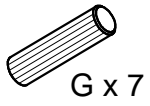

2

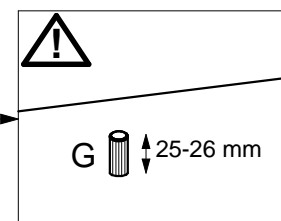
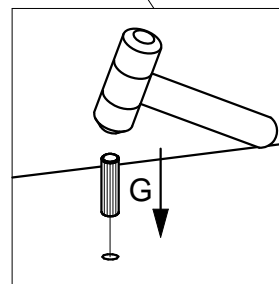
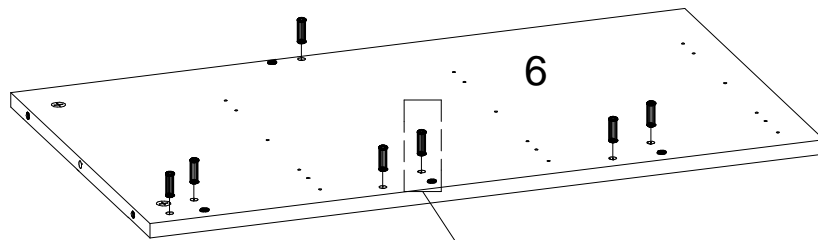
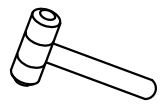

3

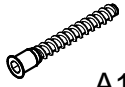

A1 x 2



A2 x 2



A3 x 1

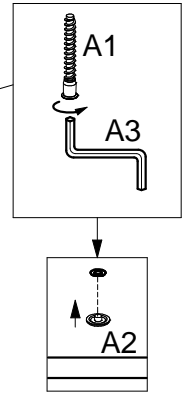
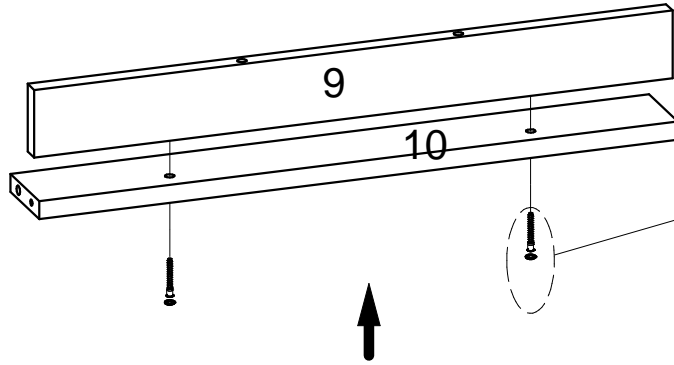

4

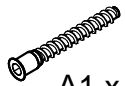

A1 x 4



A2 x 4



A3 x 1

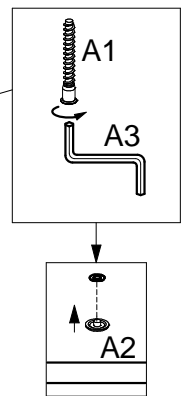
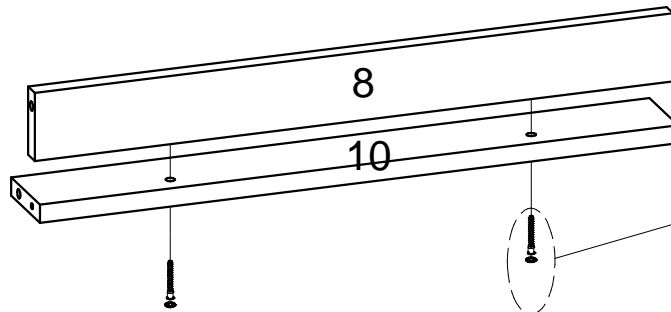

x 2

5

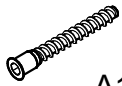

A1 x 8



A2 x 8



A3 x 1

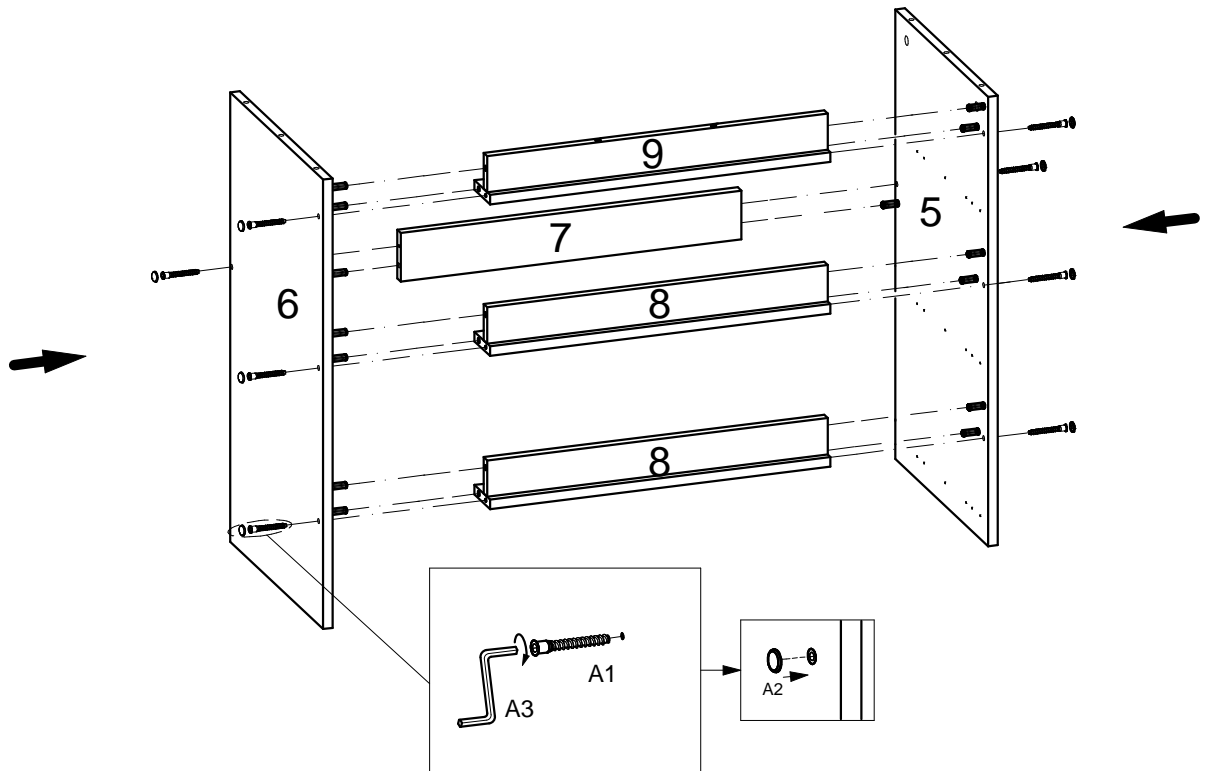
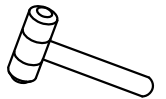

6



B2 x 4



G x 4

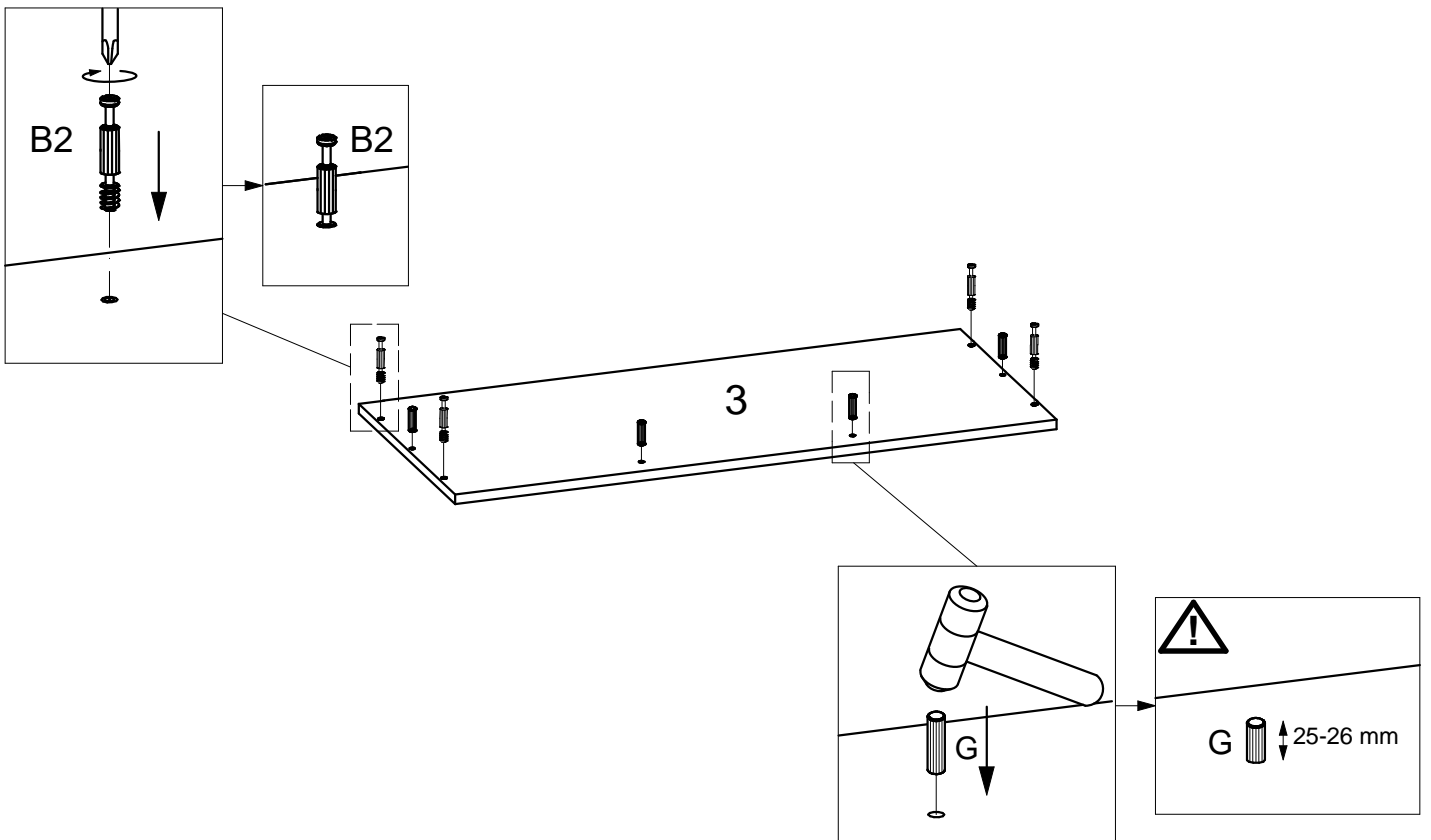
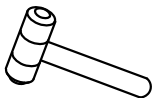
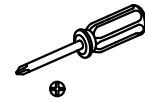

7

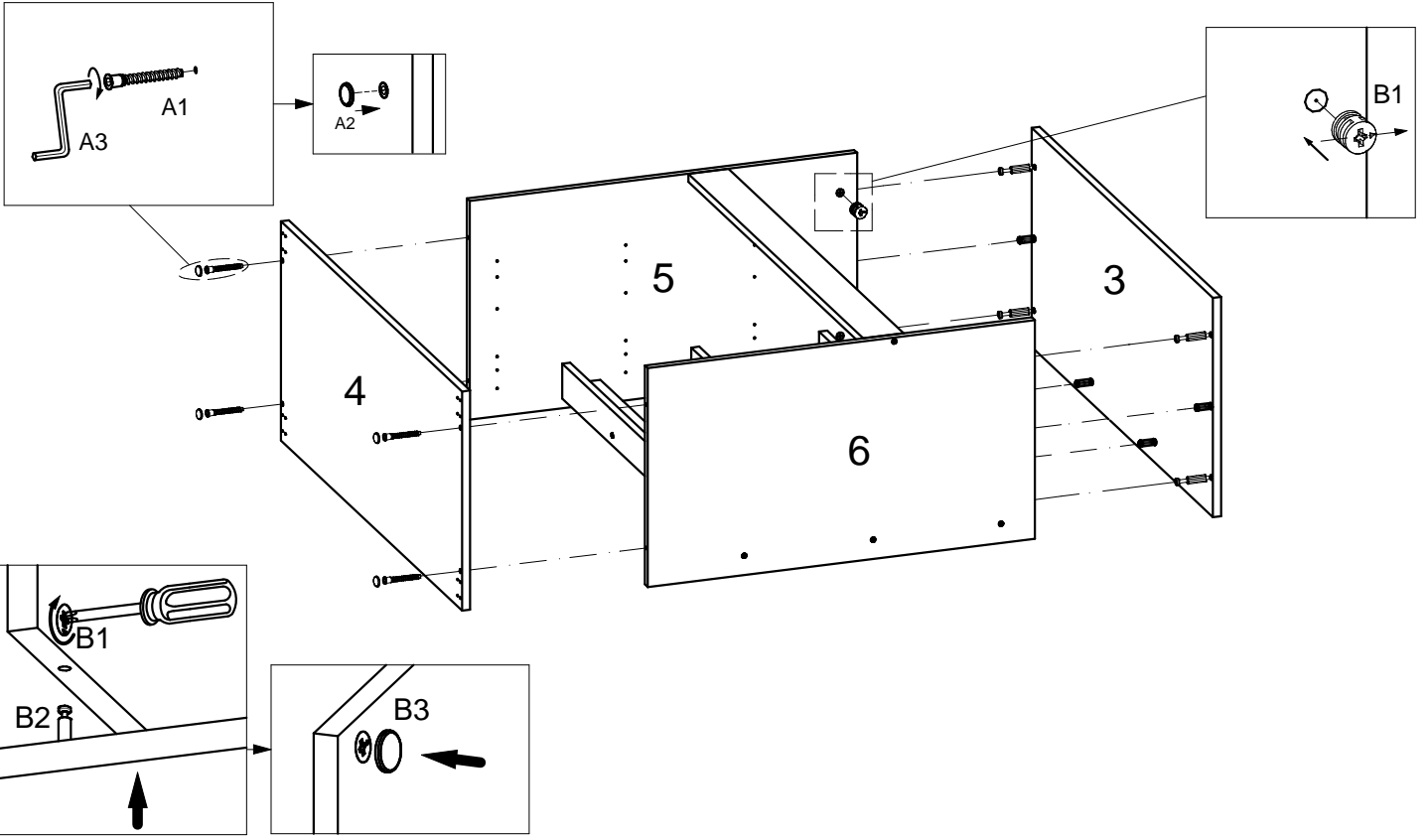
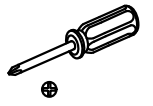
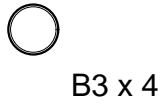
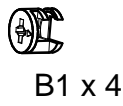
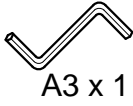
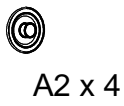
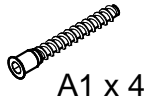

8

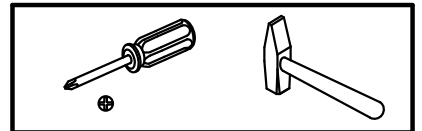
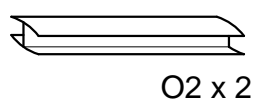
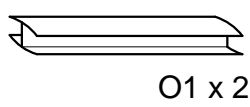
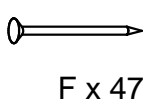
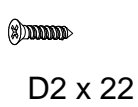

⚠ XX=YY≅90°

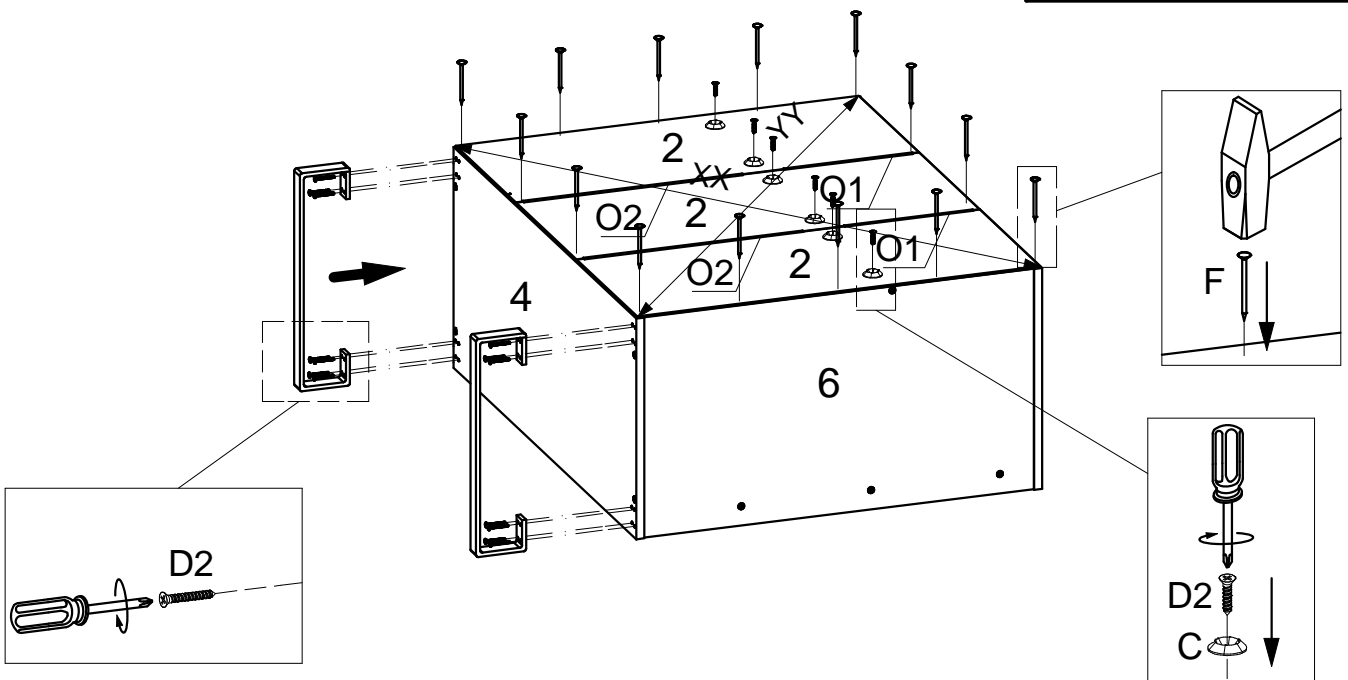

9



D1 x 18



K.1 x 3



K.2 x 3

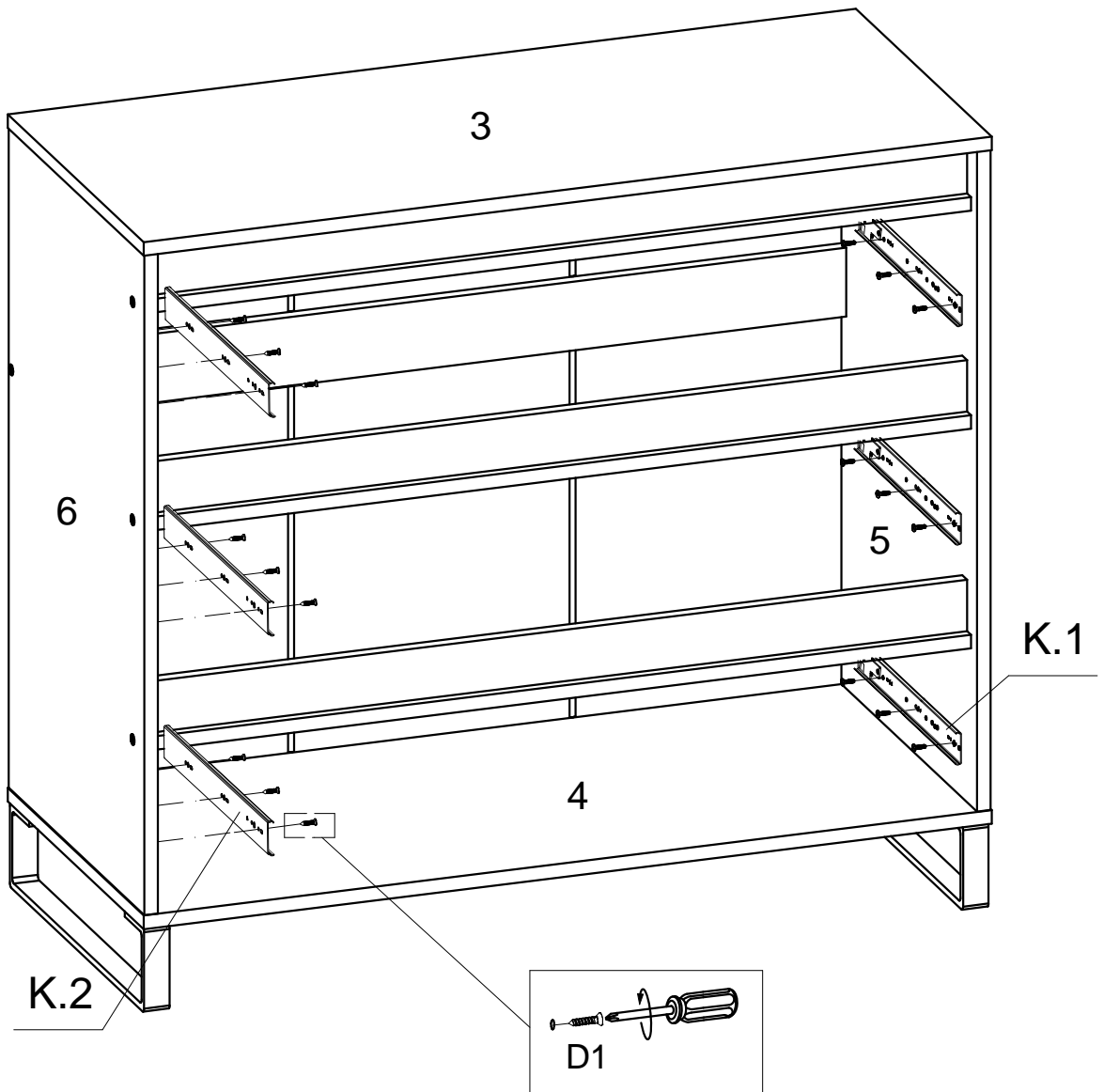
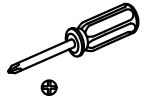

10

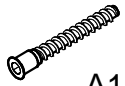

A1 x 12



A2 x 12



A3 x 1



B1 x 6

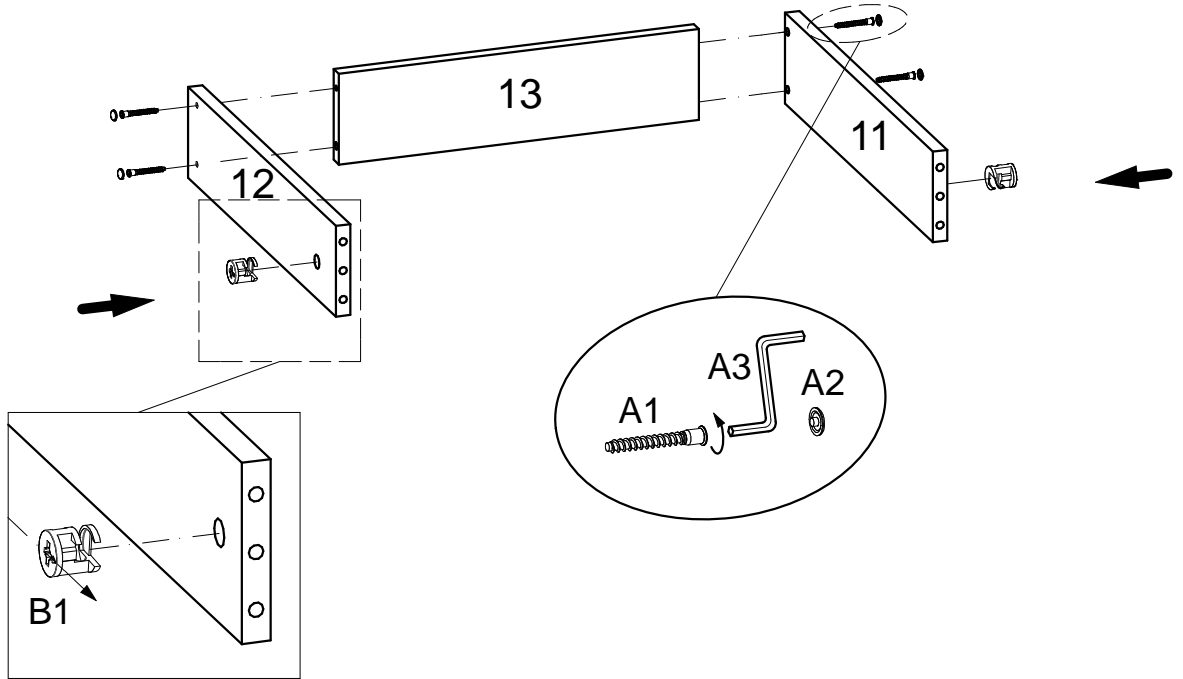

x 3

11



B2 x 6



B3 x 6



G x 12

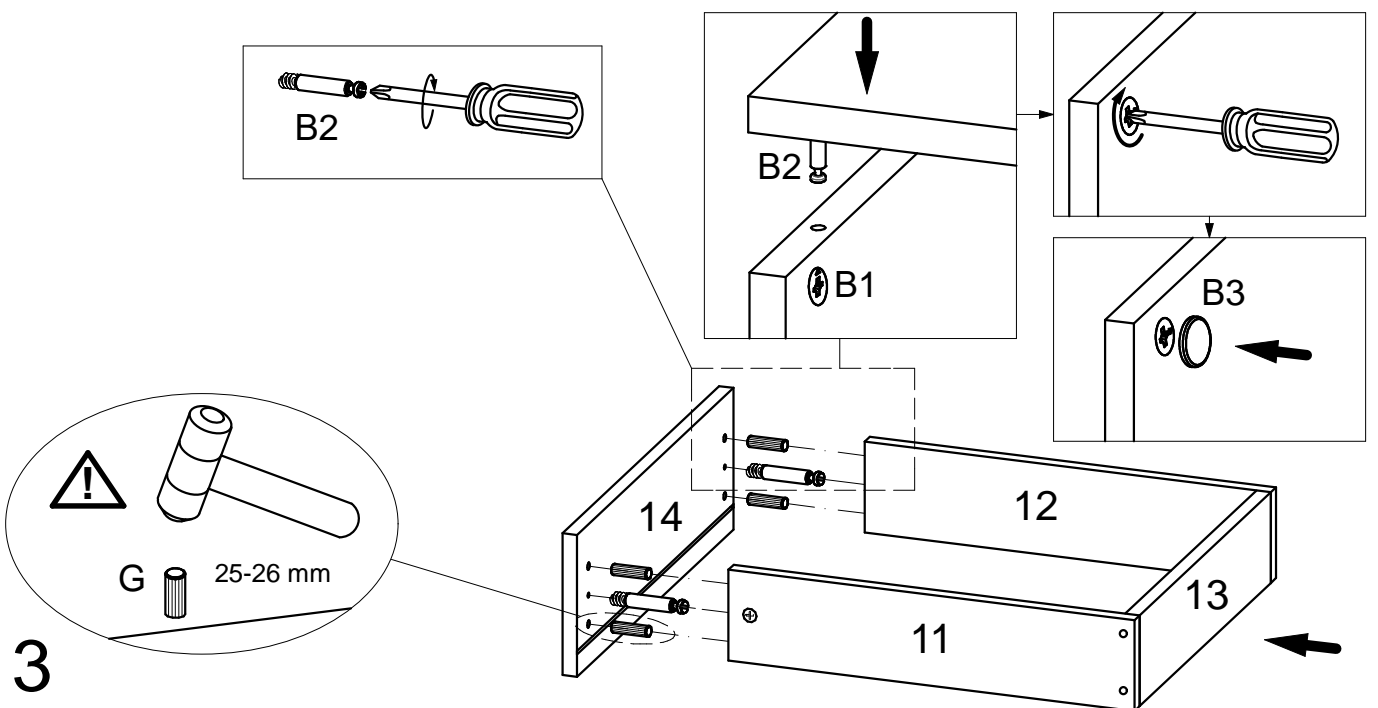
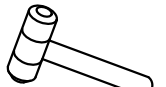
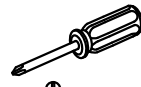

x 3

12



D1 x 6

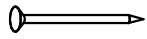

F x 96

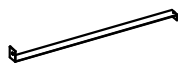

I x 3

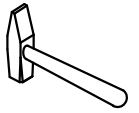
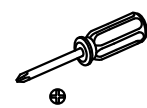

$XX=YY\cong 90^\circ$

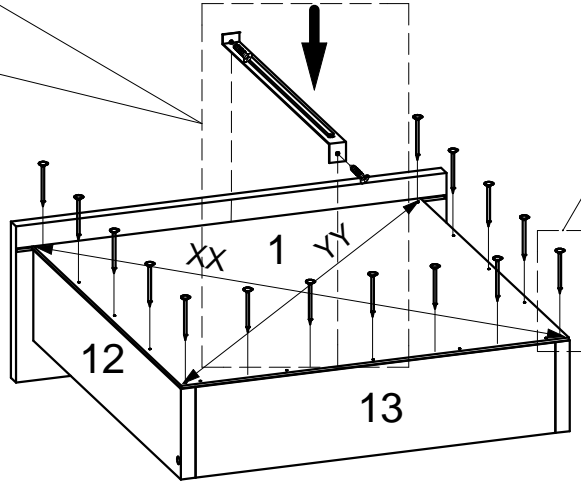
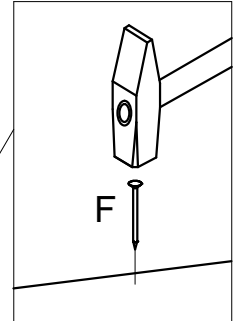
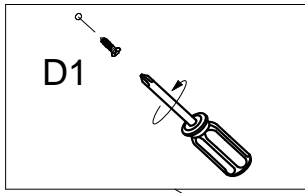
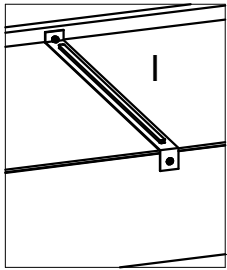

x 3

13



D1 x 18



K.3 x 3



K.4 x 3

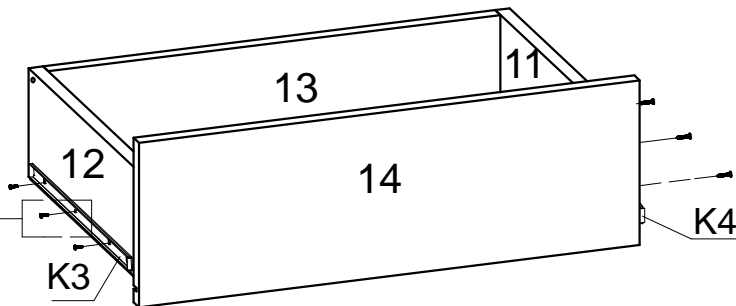
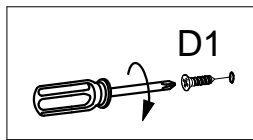
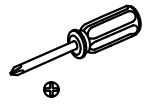

x 3

14

